

MOUNTING THE RECEIVER

Using the hardware supplied, mount the receiver to the wall next to the irrigation controller. It is recommended that the receiver be installed away from sources of electrical interference and metal objects to maximize communication range. Extend and straighten the antenna upward. Make sure to attach the rubber cover under the receiver when installing the receiver in an outdoor location.

Wiring the Receiver to your Controller

WARNING! This unit is designed to be installed in conjunction with 24 VAC circuits only. Do not use with 110 or 220 VAC circuits.

Wiring the Receiver to a Hunter SRC

1. Attach the two yellow wires to the AC terminals.
2. Attach the blue wire to the RS terminal.
3. Attach the white wire to the C terminal.
4. Attach the valve common wire to the RS terminal.

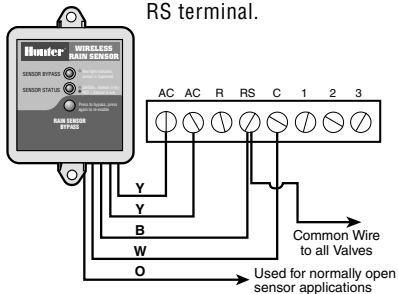

MOUNTING THE RECEIVER (continued)

Wiring the Receiver to a Hunter EC, XC, Pro-C, ICC and ACC

1. Remove the sensor jumper across the two SEN terminals.
2. Attach the two yellow wires to the AC terminals.
3. Attach the blue wire to one SEN terminal and the white wire to the other SEN terminal.

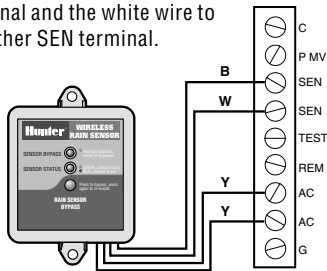

Wiring the Receiver to Other Controllers: Normally Closed Sensor Applications

1. Attach the two yellow wires to the AC terminals.
2. Attach the blue and white wire to the sensor terminals (if available) or in-line with the valve common wire.

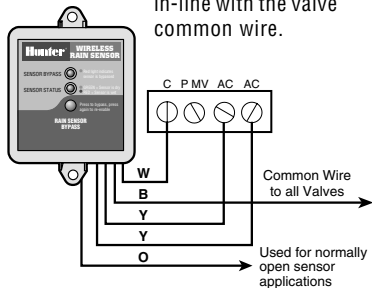

Normally Open Sensor Applications

1. A few controllers on the market require normally open rain sensors. To attach the receiver to this type of controller, attach the blue and orange wire to the sensor input.

Controllers with 24 VAC solenoids and a booster pump

1. Locate the common wire to the solenoid valves and the common wire to the pump relay. If these two wires are connected to the “common” terminal on the controller, disconnect both of them.
2. Twist together these wires along with one of the wires from the Wireless Rain-Clik™ and secure with a wire nut.
3. Attach the other wire from the

Wireless Rain-Clik receiver to the “common” terminal on the controller.

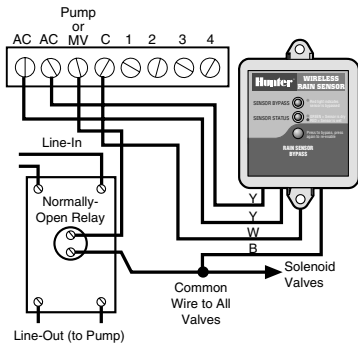

NOTE: The pump circuit output must be 24 VAC. Do not proceed if 115VAC.

MOUNTING THE TRANSMITTER

Standard Mounting

Using the screws provided with your sensor, mount the transmitter on any surface where it will be exposed to unobstructed rainfall, but not in the path of sprinkler spray.

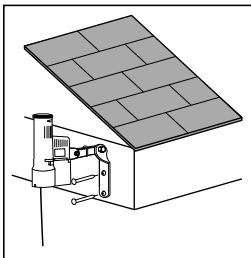

Standard Mount

The sensor should be oriented upright (as pictured), but the swivel bracket can be moved for mounting on any angled surface. Loosen the locknut and screw before swiveling the bracket, and then re-tighten.

Gutter Mounting (Optional)

The sensor gutter mount can be purchased as an optional accessory for your Wireless Rain-Clik (order p/n SGM). The SGM allows the transmitter to be mounted directly to the edge of a gutter. Install the SGM on the transmitter by removing the metal extension arm supplied with your sensor and reinstalling the SGM. Position the gutter mount on the edge of the gutter and twist the thumbscrew to secure it in place.

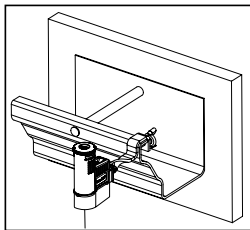

Gutter Mount

Hints for mounting the transmitter

- A. Choose a location such as the side of a building or post. The closer the transmitter is to the receiver, the better the reception. Do not exceed 1,000 ft.
- B. To assure maximum range in communication, mount the receiver and transmitter away from sources of electrical interference (i.e. control panels, transformers, etc.) or metal objects. Best performance is obtained when no physical obstruction is between the transmitter and receiver.
- C. Correct placement of the Wireless Rain/Freeze-Clik model is important for accurate temperature sensing. The best location would be out of direct sunlight.
- D. The reset rate refers to the amount of time it takes for the sensor to dry out sufficiently for the sprinkler system to be allowed to come back on. The mounting location will affect this rate. For example, mounting the transmitter in a very sunny location may cause the sensor to dry out sooner than desired. Similarly, mounting the sensor in constant shade may keep the sensor from drying out sooner.

ADJUSTMENTS AND OPERATION

Transmitter Operation

There is nothing to set up with the Wireless Rain-Clik™.

Receiver Operation

The receiver has two LED lights that indicate the state of the system.

SENSOR STATUS LED:

RED – sensor is wet (watering disabled)

GREEN – sensor dry (watering enabled)

YELLOW – sensor is in addressing mode

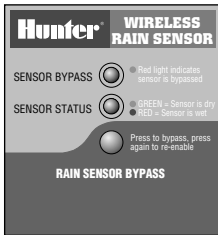

SENSOR BYPASS LED:

RED – rain sensor is bypassed (even though the sensor is bypassed, the STATUS LED will continue to alert you of the state of the sensor (wet or dry).

OFF – rain sensor is enabled.

FLASHING RED – indicates that communication between the transmitter and receiver was lost.

NOTE: When you first apply power to the receiver, the **SENSOR STATUS LED** will be **RED**. Press the manual test spindle on the transmitter for 5 seconds and release the spindle. The **SENSOR STATUS LED** will turn **GREEN** indicating proper operation.

Bypassing the Sensor

The sensor may be bypassed by using the built in bypass feature on the receiver. To bypass the sensor, press the SENSOR BYPASS button on the receiver. The bypass status light will turn red when the sensor is bypassed. Pressing the SENSOR BYPASS button again will re-enable the sensor and the sensor bypass light will go out.

Setting the Transmitter Address at the Receiver

NOTE: Units purchased as a kit will already have their communication address preset. No addressing is necessary, however, if the receiver or transmitter is replaced you need to reset the address.

Each transmitter is produced with a unique address. A receiver must learn this address to work with that transmitter. This step is only necessary if transmitters and receivers are purchased separately.

ADJUSTMENTS AND OPERATION (continued)

1. Prior to applying power (yellow wires) to the receiver, press and hold the bypass button on the receiver.
2. While the bypass button is depressed, apply power to the receiver. The sensor status indicator light should light up yellow indicating that the receiver is ready to learn a new address.
3. Press and hold the quick response button on the transmitter.
4. Within 4 seconds, the receiver's sensor status indicator light should turn red. The receiver has now learned the address and it will be retained even in the event of a power outage.
5. Release the button on the transmitter. The sensor status indicator light should turn green.

Battery Life

The Wireless Rain-Clik™ transmitter is designed to operate up to ten years with its sealed, maintenance-free battery. The transmitter is available as a replacement part. (WRC-TR) Should you need to change the transmitter, the receiver will have to learn the new transmitter address.

To check the status of the battery in the transmitter:

1. Press and hold the quick response spindle at the top of the sensor.

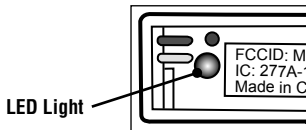

2. Within a few seconds the LED light on the bottom of the sensor will briefly flash.
3. Release the spindle and the LED light will flash again. If the LED flashes, the battery in the transmitter is good.

If you are experiencing problems with your Wireless Rain-Clik™ sensor, follow these simple checks first before assuming the unit is defective and replacing it.

System will not come on at all:

- A. Check to make sure that the sensor discs are dry and the switch “clicks” on and off freely by pressing the top of the spindle.
- B. Look for breaks in the wire leading to the receiver and check all connections.
- C. Verify outside air temperature (for Rain/Freeze-Clik installations).

System will not shut off even after heavy rainfall:

- A. Remove the sensor jumper across the two SEN terminals.
- B. Check to make sure that rainfall is hitting the sensor.
- C. Look for breaks in the wire leading to the receiver and check all connections.
- D. Check the battery in the transmitter (see page 12).

Sensor Bypass LED is flashing red:

- A. Check that the battery in the transmitter is good (see page 12).
- B. Check for obstructions around the transmitter or receiver antennae.

COMPLIANCE NOTICE

FCC Compliance Notice

This notice applies only to models WRC-TR and WRFC-TR.

This device complies with FCC rules Part 15. Operation is subject to the following two conditions:

1. This device may not cause harmful interference and
2. This device must accept any interference that may be received, including interference that may cause undesired operation.

Transmitter FCC ID: M3UWSSTX

This equipment has been tested and found to comply with the limits for a class B digital device, pursuant to part 15 of the

FCC Rules. These limits are designed to provide reasonable protection against harmful interference in a residential installation. This equipment generated, uses and can radiate radio frequency energy and if not installed and used in accordance with the instructions, may cause harmful interference to radio communications. However, there is no guarantee that interference will not occur in a particular installation. If this equipment does cause harmful interference to radio or television reception, which can be determined by turning the equipment off and on, the user is encouraged to try to correct the interference by one or more of the following measures:

- Reorient or relocate the receiving antenna
- Increase the separation between the equipment and receiver

- Connect the equipment into an outlet on a circuit different from that to which the receiver is connected
- Consult the dealer or an experienced radio/TV technician for help

Industry of Canada Notice

This notice applies only to models WRC-TR and WRFC-TR

IC: 277A-14198

WRC-R: This Class B digital apparatus complies with Canadian ICES-003.

The term “IC:” before the certification/ registration number only signifies that the Industry of Canada technical specifications were met.

Operation is subject to the following two conditions: (1) this device may not cause interference, and (2) this device must accept any interference, including interference that may cause undesired operation of the device.

CE NOTICE.....

CE Notice: this notice applies only to models WRC-INT.				
		Important Notice: Low power RF product operating in 433.92MHz band for indoor or outdoor home and commercial use.		
AUS	B	DK	FIN	Member states in the EU with restrictive use for this product are crossed out.
F	D	GR	IRE	
I	LUX	NL	P	
E	S	UK		

Hunter Industries Incorporated • The Irrigation Innovators

1940 Diamond Street • San Marcos, California 92078

www.HunterIndustries.com

© 2005 Hunter Industries Incorporated

P/N 715182 23-594 10/05